

EPSILON XCHANGE™ Tool Changer ER100/ET100

ER100/ET100 is an automatic tool changing assembly for exchanging robotic end-of-arm tooling (EOAT) on the fly.

Advantages

- High Strength Aluminum Alloy Body
- Cam Locking Mechanism with **Lifetime Guarantee**
 - Self-Centering
 - Wear Compensating
 - Self-Cleaning
 - Positive Cam Retraction
 - Mechanical Locking (Loss of Air)
- Flexible Utility Options
- Couple/Uncouple Sensing Optional

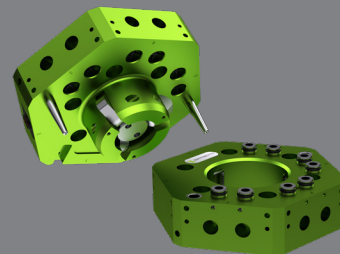

SPECIFICATIONS

Model	Rated Payload	Operating Moment (Mx, My)	E-Stop Moment (Mx, My)	Operating Torque (Mz)	E-Stop Torque (Mz)	Diameter or width x length	Height coupled	Repeatability	User flow	Weight
E31.5	10 kg 22 lb	52 Nm 460 in-lb	79 Nm 699 in-lb	30 Nm 266 in-lb	60 Nm 531 in-lb	Ø46 mm Ø1.81 in	36 mm 1 in	± 0.04°	0.18 Cv	0.13 kg 0.29 lb
E50	25 kg 55 lb	88 Nm 779 in-lb	168 Nm 1487 in-lb	120 Nm 1062 in-lb	375 Nm 3319 in-lb	Ø85 mm Ø3.35 in	48 mm 2 in	± 0.02°	0.27 Cv	0.59 kg 1.30 lb
E63	50 kg 110 lb	112 Nm 991 in-lb	168 Nm 1487 in-lb	220 Nm 1947 in-lb	375 Nm 3319 in-lb	Ø85 mm Ø3.35 in	48 mm 2 in	± 0.02°	0.27 Cv	0.60 kg 1.32 lb
E80	90 kg 198 lb	465 Nm 4116 in-lb	890 Nm 7877 in-lb	640 Nm 5664 in-lb	1585 Nm 14028 in-lb	Ø152 mm Ø5.98 in	72 mm 3 in	± 0.01°	0.37 Cv	2.74 kg 6.04 lb
E100	120 kg 265 lb	548 Nm 4850 in-lb	890 Nm 7877 in-lb	960 Nm 8497 in-lb	1585 Nm 14028 in-lb	Ø152 mm Ø5.98 in	72 mm 3 in	± 0.01°	0.37 Cv	2.68 kg 5.91 lb
E125LP	225 kg 496 lb	1737 Nm 15374 in-lb	2875 Nm 25446 in-lb	2020 Nm 17879 in-lb	3953 Nm 34987 in-lb	Ø190 mm Ø7.48 in	94 mm 4 in	± 0.01°	0.92 Cv	5.43 kg 11.97 lb
E125	350 kg 772 lb	2576 Nm 22800 in-lb	4817 Nm 42634 in-lb	4180 Nm 36996 in-lb	5110 Nm 45227 in-lb	175.0 x 224.0 mm 6.89 x 8.82 in	120 mm 5 in	± 0.01°	N/A	9.22 kg 20.33 lb
E160	525 kg 1158 lb	3775 Nm 33412 in-lb	5787 Nm 51219 in-lb	4800 Nm 42484 in-lb	5945 Nm 52618 in-lb	242.9 x 280.5 mm 9.56 x 11.04 in	120 mm 5 in	± 0.01°	N/A	13.86 kg 30.16 lb
E160 (STL)*	600 kg 1323 lb	4300 Nm 38058 in-lb	9095 Nm 80498 in-lb	4800 Nm 42484 in-lb	5945 Nm 52618 in-lb	242.9 x 280.5 mm 9.56 x 11.04 in	120 mm 5 in	± 0.01°	N/A	13.89 kg 30.62 lb
ES160	800 kg 1764 lb	5649 Nm 49998 in-lb	11322 Nm 100208 in-lb	5280 Nm 46732 in-lb	6690 Nm 59211 in-lb	242.9 x 280.5 mm 9.56 x 11.04 in	120 mm 5 in	± 0.01°	N/A	18.03 kg 39.75 lb
ES200	1500 kg 3308 lb	15097 Nm 133620 in-lb	17998 Nm 159296 in-lb	11660 Nm 103200 in-lb	14590 Nm 129132 in-lb	310.0 x 358.0 mm 12.20 x 14.09 in	120 mm 5 in	± 0.01°	N/A	28.53 kg 62.90 lb
ES315	2300 kg 5072 lb	43135 Nm 381777 in-lb	75533 Nm 668523 in-lb	31144 Nm 275648 in-lb	48882 Nm 432642 in-lb	425.0 x 490.8 mm 16.7 x 19.3 in	171 mm 7 in	± 0.01°	N/A	103.24 kg 227.61 lb

*E160 (STL) utilizes a steel tool adaptor and an aluminum robot adaptor.

Supply Pressure **5 - 7 bar**

Operating Temperature **5 - 60°C**

Noise Emissions (Sound Pressure) **≤ 70 dB(A) in each direction**

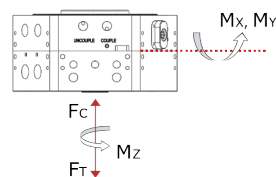

SECTIONAL DIAGRAM

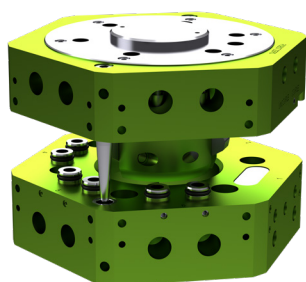

Applied Robotics XCHANGE™ automatic tool changing technology allows for exchanging robotic end-of-arm tooling (EOAT) on the fly without shutting down production lines. Not only does this add efficiency to processes requiring frequent connection/disconnection of tooling and support utilities, but also reduces the probability of human errors introduced by manual connections.

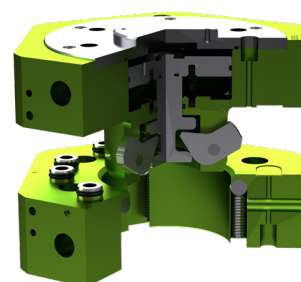

PRODUCT INFORMATION



ROBOT ADAPTOR

ROBOT ADAPTOR WEIGHT: 1.46 kg [3.21 lb]

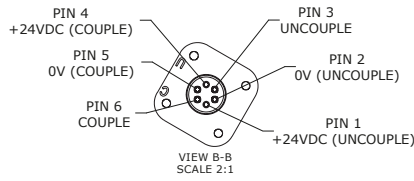
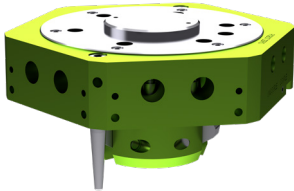

TOOL ADAPTOR

TOOL ADAPTOR WEIGHT: 1.22 kg [2.68 lb]

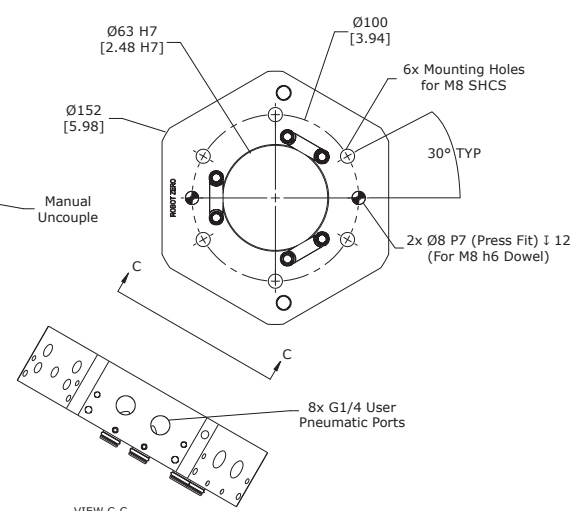
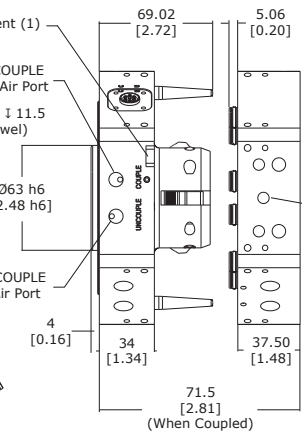
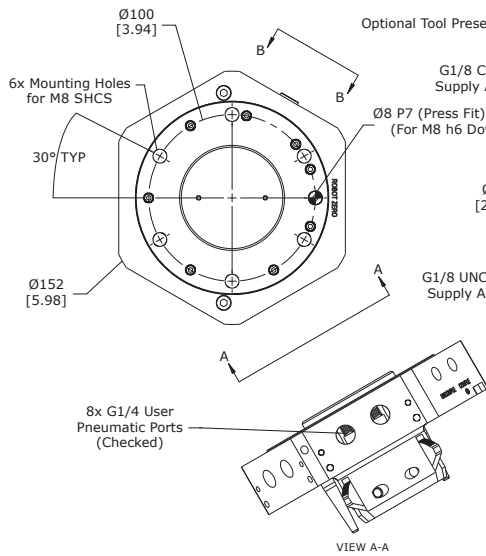
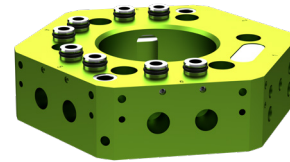

NOTE: Dimensions are mm [in]

OPTIONAL UTILITIES

E100 Robot

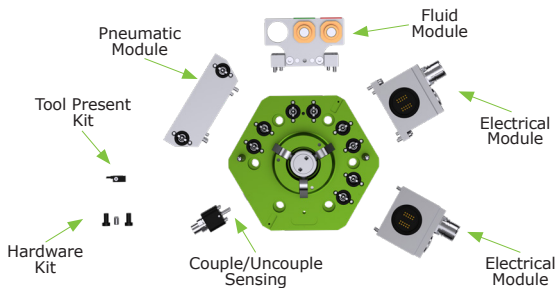

E100 Tool

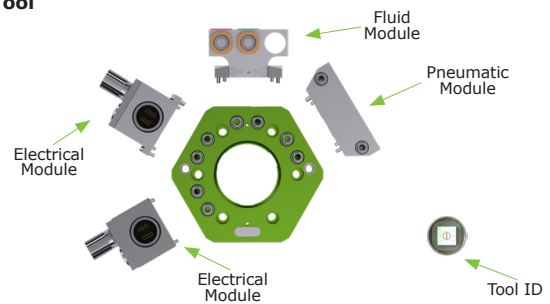

EFFECTO GROUP S.p.A.
 Via Roma, 141/143
 28017 San Maurizio d'Opaglio (NO) - IT
 Tel. +39 0322 96142
 info@effecto.com



Applied Robotics, Inc.
 648 Saratoga Road
 Glenville, NY 12302 USA
 Tel. +1 518 384 1000
 info@effectousa.com

www.effecto.com



EFFECTO GmbH
 Olchingerstrasse 109
 82194 Gröbenzell - DE
 Tel. +49(0)8142 59397-0
 info@effectogmbh.de