

ab Seite / from page

Der Systembaukasten für maßgeschneiderte Arbeitsplätze.	132
<i>The modular system for custom workbench designs</i>	
Zuführanlage+Kamerahalterungen.	133
<i>Feeding machine + camera holders</i>	
Beobachtungsplattform.	134
<i>Observation platform</i>	
Schutzzäune.	135
<i>Protective fences</i>	
Messestand	137
<i>Fair stand</i>	
Roller	138
<i>Vehicle</i>	
Entnahmegreifer.	139
<i>Extraction gripping device</i>	
Schaltschrank-Montagetisch	141
<i>Switchboard</i>	
Halterungen	142
<i>Fixations</i>	
Förderbandüberbau und Seitenführungen	143
<i>Conveyor belt coinstructions</i>	
Klemmverbinder und Verstelleinheiten Übersicht.	144
<i>Clamps and linear units overview</i>	

Important notice: Explanation of the order number (order codes) and additionally some order examples see page 15 + 16. Further options for clamps, like other screws, clamping levers in different sizes, surface treatment and coating, and special treatments see page 18 and upwards. Suitable tubes in steel, stainless steel and aluminium up to maximum 6000 mm in any desired length (up from 500 mm with no extra charge for cutting), inside and outside deburred, see page 122 and upwards.

INOCON GmbH
Industriestraße 31 • 53359 Rheinbach
Tel.: (+49) 0 22 26 - 909 87-0
Fax: (+49) 0 22 26 - 909 87-99



Der Systembaukasten für maßgeschneiderte Arbeitsplätze

The modular system for custom workbench designs

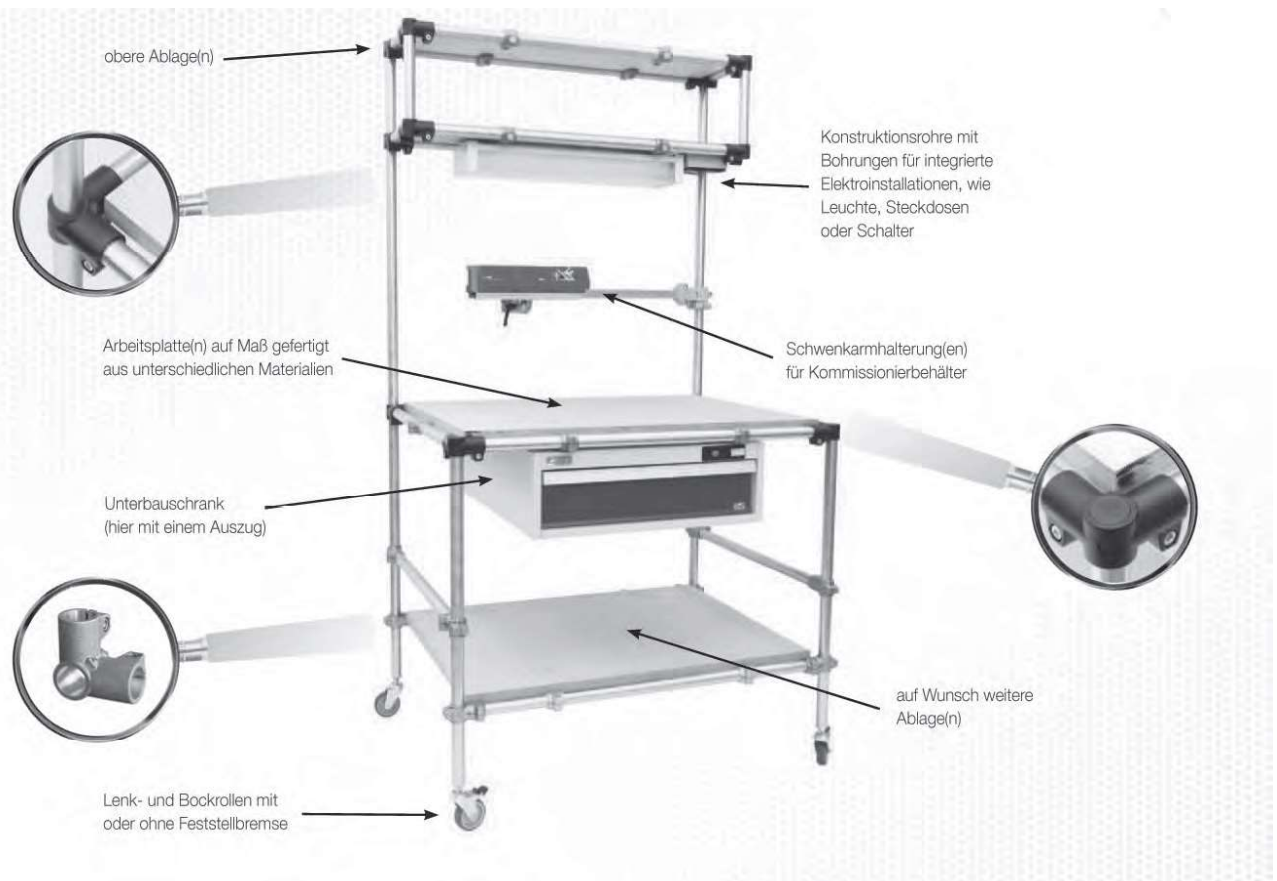

Höhe, Breite, Tiefe auf Maß gefertigt und alle Optionen nach Ihren Vorgaben. Stellen Sie Ihren spezifischen Aufbau zusammen, und passen diesen bei Bedarf an geänderte Aufgabenstellungen an.

Custom height, width and depth, and all options according to your requirements. Select your own specific design and make adjustments when your work changes.



Zuführanlagen mit Werkstückabfragesystemen aus Kreuzklemmverbindern Typ KNK
Delivery systems with work piece polling systems of cross clamp type KNK

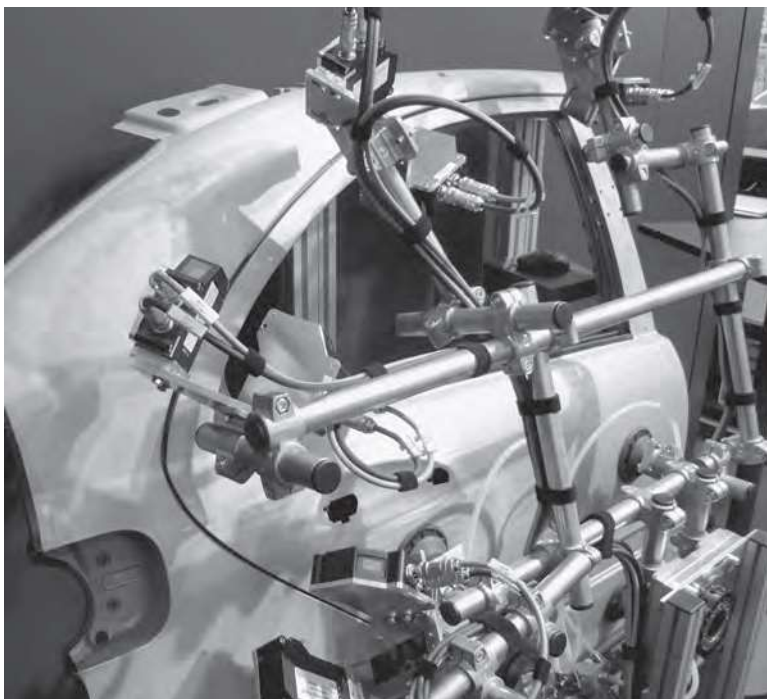

Qualitätssicherungssystem mit Kamera- und Sensorhalterungen in der Automobilindustrie
mittels Klemmverbinder-Konstruktionssystem
*Quality assurance system with fittings for cameras and sensors in the automobile industry
by using of tube connection system*

Important notice: Explanation of the order number (order codes) and additionally some order examples see page 15 + 16. Further options for clamps, like other screws, clamping levers in different sizes, surface treatment and coating, and special treatments see page 18 and upwards. Suitable tubes in steel, stainless steel and aluminium up to maximum 6000 mm in any desired length (up from 500 mm with no extra charge for cutting), inside and outside deburred, see page 122 and upwards.

INOCON GmbH
Industriestraße 31 • 53359 Rheinbach
Tel.: (+49) 0 22 26 - 909 87-0
Fax: (+49) 0 22 26 - 909 87-99



Beobachtungsbühne / *Observation platform*

Eckverbindung / *Edge joint*



Türelement / *Door element*

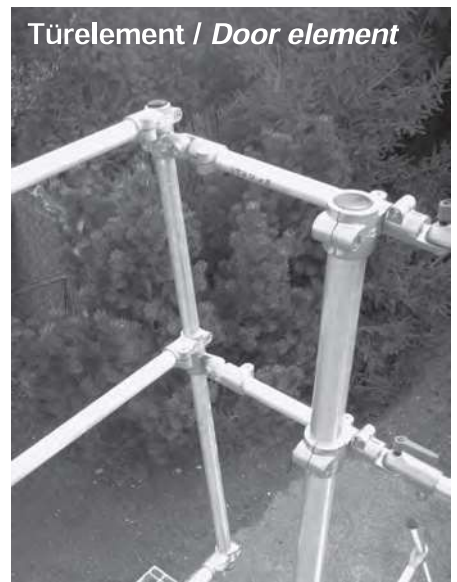

Verfahrrolle
Transport wheel

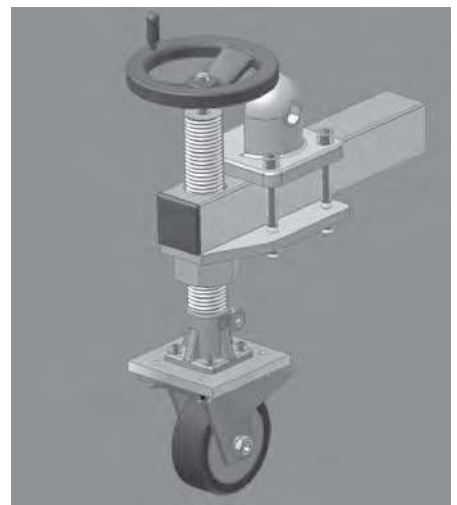

INOCON GmbH
Industriestraße 31 • 53359 Rheinbach
Tel.: (+49) 0 22 26 - 909 87-0
Fax: (+49) 0 22 26 - 909 87-99

Wichtige Hinweise: Erklärung der Bestellnummer (Bestellschlüssel) sowie ausführliche Bestellbeispiele, siehe Seite 15 + 16. Weitere Bauteiloptionen für Klemmverbinder, wie andere Schrauben, Klemmhebel in verschiedenen Größen, Oberflächenbehandlung und -beschichtung, sowie Sonderbearbeitungen siehe ab Seite 18. Passende Rohre in Stahl, Edelstahl und Aluminium bis maximal 6000 mm in jeder gewünschten Zuschnittlänge (ab 500 mm ohne Zuschnittkosten), innen und außen entgratet, ab Seite 122.

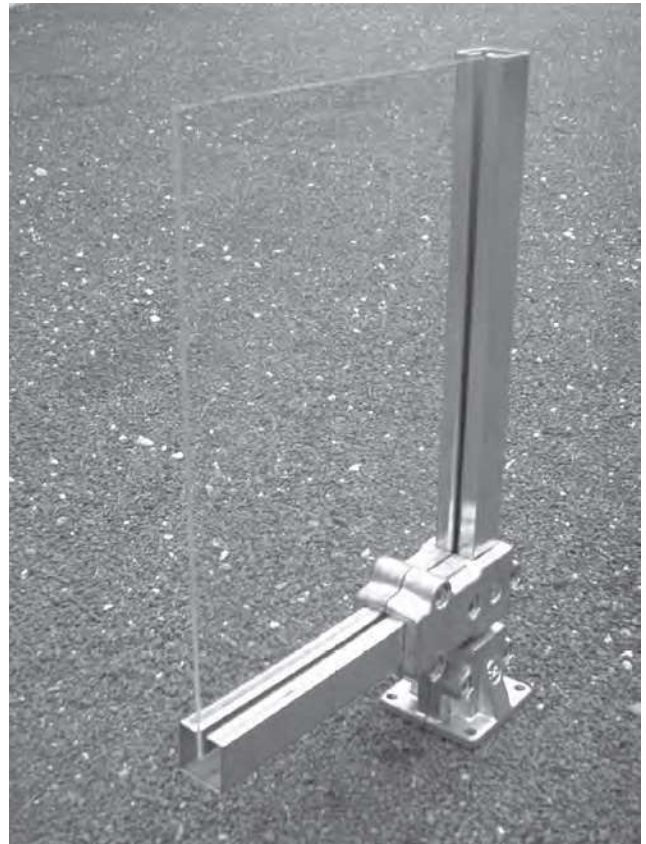
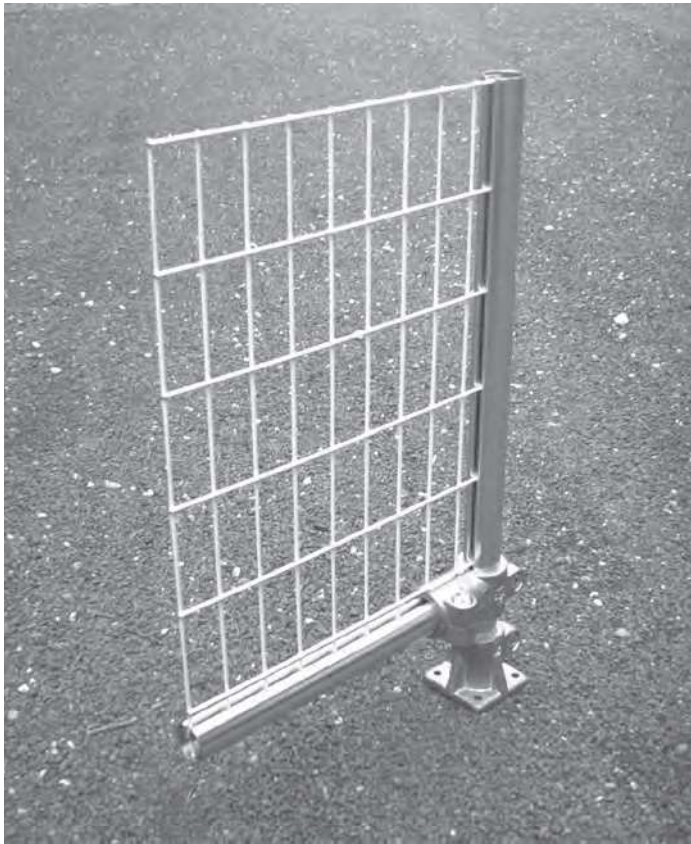

Schutzzäune aus Klemmverbindern, geschlitzten Rohren und beliebigen Flächenelementen
Protective fences consisting of clamps, slitted tubes and any kind of surface elements



Fußklemmverbinder FMR, siehe Seite 61
Pedestal clamp FMR, see page 61



Winkelklemmverbinder WIS, siehe Seite 67
Angle clamp WIS, see page 67



Winkelklemmverbinder WIV, siehe Seite 68
Angle clamp WIV, see page 68

Important notice: Explanation of the order number (order codes) and additionally some order examples see page 15 + 16. Further options for clamps, like other screws, clamping levers in different sizes, surface treatment and coating, and special treatments see page 18 and upwards. Suitable tubes in steel, stainless steel and aluminium up to maximum 6000 mm in any desired length (up from 500 mm with no extra charge for cutting), inside and outside deburred, see page 122 and upwards.

INOCON GmbH
Industriestraße 31 • 53359 Rheinbach
Tel.: (+49) 0 22 26 - 909 87-0
Fax: (+49) 0 22 26 - 909 87-99



Schutzzaun aus Klemmverbindern

Zur Maschinensicherheit oder zum Schutz Ihrer wertvollsten Dinge

Security fence assembled with clamps

Especially suited of securing machinery or protecting your most valuable possessions



INOCON GmbH
Industriestraße 31 • 53359 Rheinbach
Tel.: (+49) 0 22 26 - 909 87-0
Fax: (+49) 0 22 26 - 909 87-99

Wichtige Hinweise: Erklärung der Bestellnummer (Bestellschlüssel) sowie ausführliche Bestellbeispiele, siehe Seite 15 + 16. Weitere Bauteiloptionen für Klemmverbinder, wie andere Schrauben, Klemmhebel in verschiedenen Größen, Oberflächenbehandlung und -beschichtung, sowie Sonderbearbeitungen siehe ab Seite 18. Passende Rohre in Stahl, Edelstahl und Aluminium bis maximal 6000 mm in jeder gewünschten Zuschnittlänge (ab 500 mm ohne Zuschnittkosten), innen und außen entgratet, ab Seite 122.

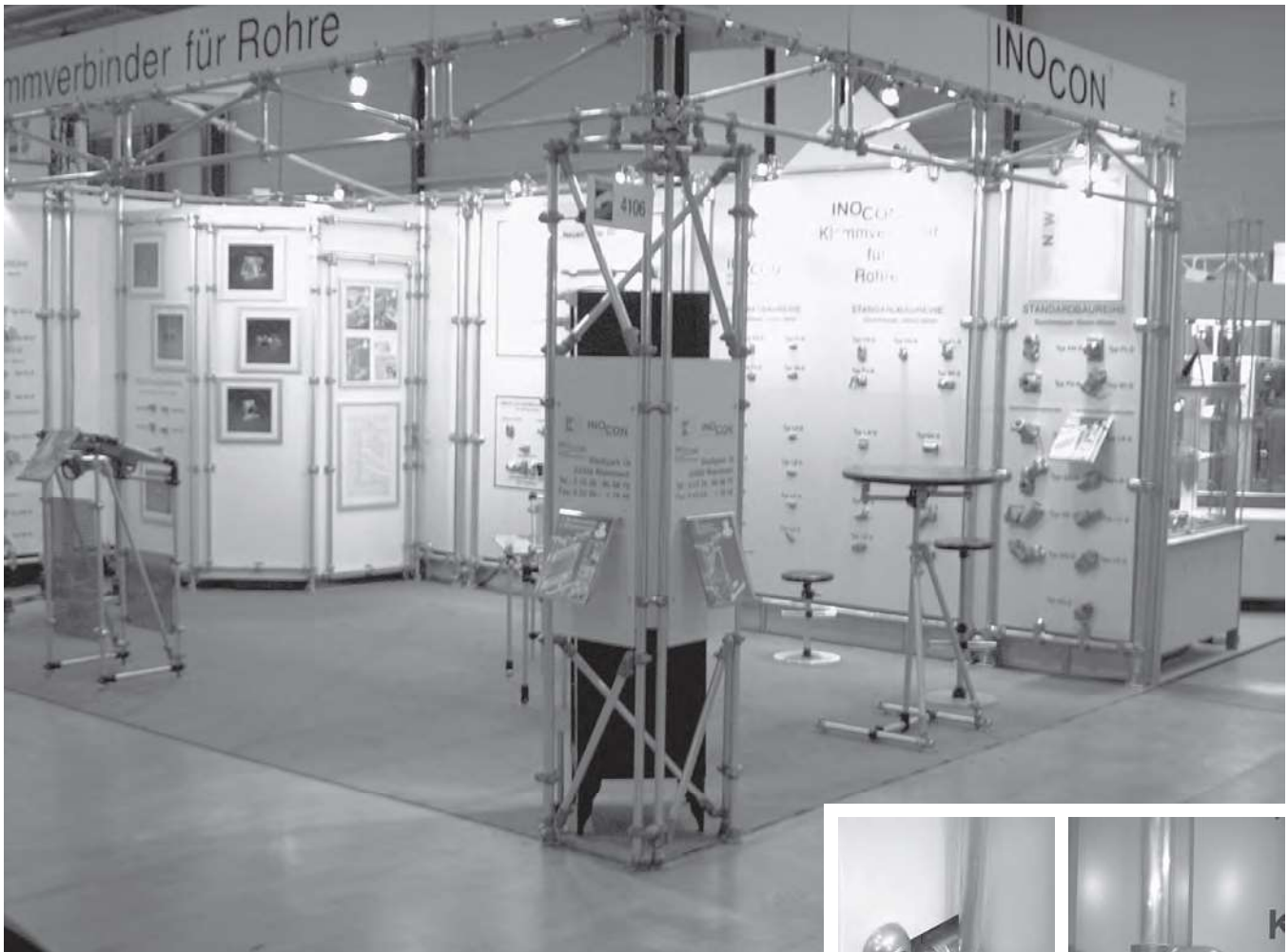

Aufbau unseres Messestandes aus Klemmverbindern als Beispiel für Möglichkeiten in diesem Bereich

Construction of our fair stand, made of clamps as an example for the possibilities in this range

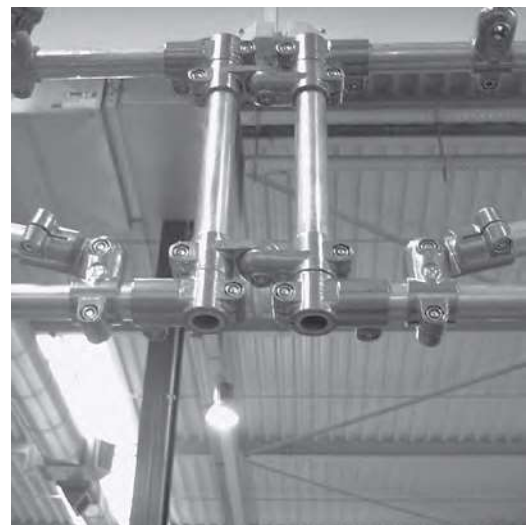

Important notice: Explanation of the order number (order codes) and additionally some order examples see page 15 + 16. Further options for clamps, like other screws, clamping levers in different sizes, surface treatment and coating, and special treatments see page 18 and upwards. Suitable tubes in steel, stainless steel and aluminium up to maximum 6000 mm in any desired length (up from 500 mm with no extra charge for cutting), inside and outside deburred, see page 122 and upwards.

INOCON GmbH
Industriestraße 31 • 53359 Rheinbach
Tel.: (+49) 0 22 26 - 909 87-0
Fax: (+49) 0 22 26 - 909 87-99

Einsatz von Klemmverbindern im Fahrzeugbau

Usage of clamps for the vehicle construction

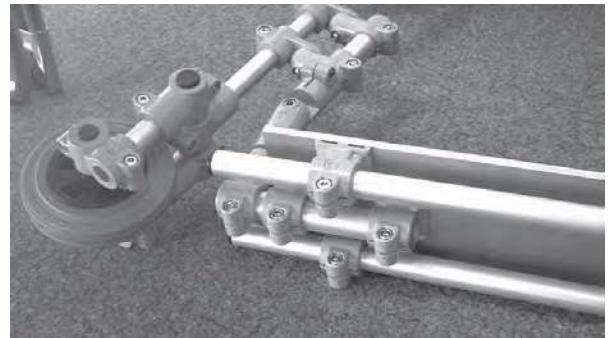
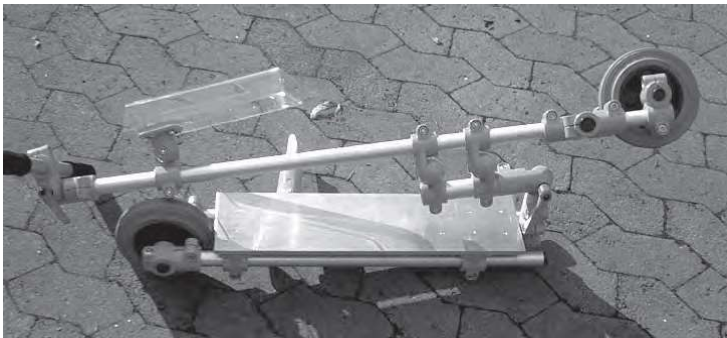
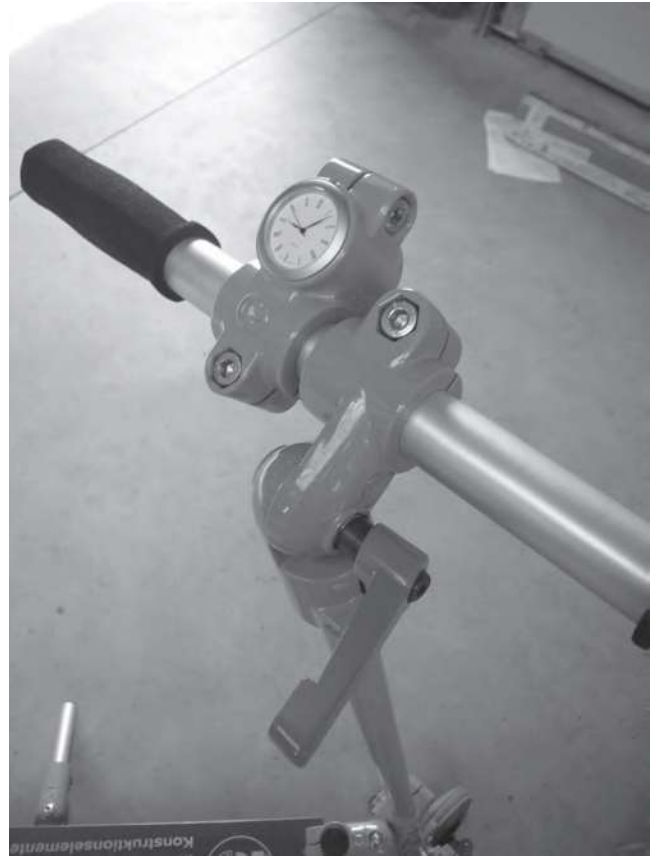

INOCON GmbH
Industriestraße 31 • 53359 Rheinbach
Tel.: (+49) 0 22 26 - 909 87-0
Fax: (+49) 0 22 26 - 909 87-99

Wichtige Hinweise: Erklärung der Bestellnummer (Bestellschlüssel) sowie ausführliche Bestellbeispiele, siehe Seite 15 + 16. Weitere Bauteiloptionen für Klemmverbinder, wie andere Schrauben, Klemmhebel in verschiedenen Größen, Oberflächenbehandlung und -beschichtung, sowie Sonderbearbeitungen siehe ab Seite 18. Passende Rohre in Stahl, Edelstahl und Aluminium bis maximal 6000 mm in jeder gewünschten Zuschnittlänge (ab 500 mm ohne Zuschnittkosten), innen und außen entgratet, ab Seite 122.



Entnahmegreifer für Kunststoffteile aus
Klemmverbindern und Rohren
*Extraction gripping device for plastic parts,
made of clamps and tubes*

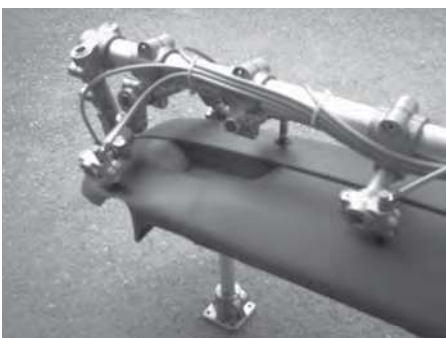

Important notice: Explanation of the order number (order codes) and additionally some order examples see page 15 + 16. Further options for clamps, like other screws, clamping levers in different sizes, surface treatment and coating, and special treatments see page 18 and upwards. Suitable tubes in steel, stainless steel and aluminium up to maximum 6000 mm in any desired length (up from 500 mm with no extra charge for cutting), inside and outside deburred, see page 122 and upwards.

INOCON GmbH
Industriestraße 31 • 53359 Rheinbach
Tel.: (+49) 0 22 26 - 909 87-0
Fax: (+49) 0 22 26 - 909 87-99



Entnahmegreiferbau für kleine Blechtafeln

Gesamtaufbau des Greifers nur aus Klemmverbindern und Rohren ohne jeglichen Adapter

Construction of an extraction gripping device for small tin plates

The complete construction of a gripping device, simply made of clamps and tubes without any adapter



INOCON GmbH
Industriestraße 31 • 53359 Rheinbach
Tel.: (+49) 0 22 26 - 909 87-0
Fax: (+49) 0 22 26 - 909 87-99

Wichtige Hinweise: Erklärung der Bestellnummer (Bestellschlüssel) sowie ausführliche Bestellbeispiele, siehe Seite 15 + 16. Weitere Bauteiloptionen für Klemmverbinder, wie andere Schrauben, Klemmhebel in verschiedenen Größen, Oberflächenbehandlung und -beschichtung, sowie Sonderbearbeitungen siehe ab Seite 18. Passende Rohre in Stahl, Edelstahl und Aluminium bis maximal 6000 mm in jeder gewünschten Zuschnittlänge (ab 500 mm ohne Zuschnittkosten), innen und außen entgratet, ab Seite 122.

Schaltschrank-Montagetisch / Assembly stand for switchboards

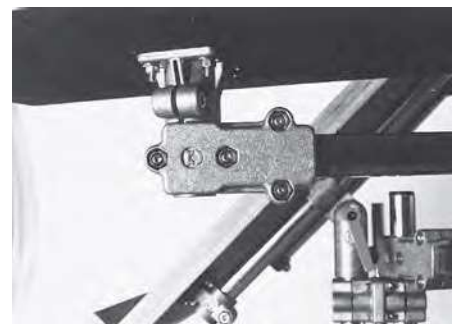
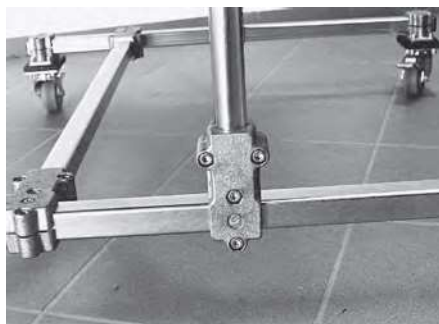
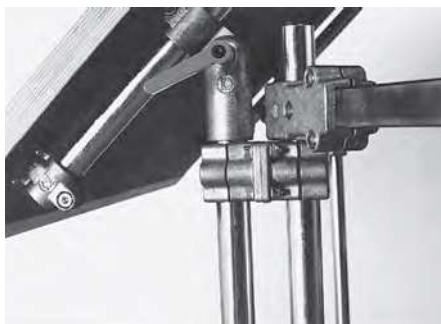

Important notice: Explanation of the order number (order codes) and additionally some order examples see page 15 + 16. Further options for clamps, like other screws, clamping levers in different sizes, surface treatment and coating, and special treatments see page 18 and upwards. Suitable tubes in steel, stainless steel and aluminium up to maximum 6000 mm in any desired length (up from 500 mm with no extra charge for cutting), inside and outside deburred, see page 122 and upwards.

INOCON GmbH
Industriestraße 31 • 53359 Rheinbach
Tel.: (+49) 0 22 26 - 909 87-0
Fax: (+49) 0 22 26 - 909 87-99