

Operating Instructions

Lubricus Lubrication System

LUB-B1/LUB-B2

(Battery)



Table of Contents

Contents	2
1) General Information	2
1.1 Warning	3
1.2 Scope of supply	
1.3 Overview – the Lubricus Lubrication System	
Symbols and notes	4
1.5 Intended use	
1.6 Liability and extent of guarantee	5
2) Safety Information	6
2.1 General safety information	
2.2 Transport and storage	7
2.3 Installation	
2.4 Maintenance	
3) Function/Principle	9
3.1 Starting	
3.2 Setting options	
Commissioning (switch on / switch off / resetting)	10
4.1 General information	
4.2 Starting Lubricus for the first time	
4.3 Switching off Lubricus	
4.4 Ventilating the lubrication system	11
4.5 Programming Lubricus	12
4.6 Quick Check – dispensing a single dose	13
4.7 Switching off Lubricus	
5) Display, Messages, Errors (shown on LCD/LED)	14
5.1 Error messages on the display	
6) Maintenance: cartridge and battery changing	15
7) Technical Data	16
8) Installation – Lubricus Lubrication System	17
9) Recommended tube lengths	18
10) Disposal	19
11) Appendix	20
11.1 List of tables and diagrams	
11.2 Table of lubrication intervals LUB-B-1	21
11.3 Table of lubrication intervals LUB-B-2	22

1) General information

Thank you very much for choosing the **Lubricus Lubrication System**.

Please ensure you familiarise yourself with the safety instructions before using the pump and accessories supplied. This manual contains important safety information.

- The Lubricus Lubrication System is a very compact lubrication pump for oil and grease up to NLGI class 2.
- The Lubricus types LUB-B1 and LUB-B2 are made for battery-powered independent operation and do not require a mains connection.
- The lubricant reservoir (400 cm³) is in a rigid, disposable cartridge.
- Supply pressure is <70 bar.
- Depending on the model, the Lubricus Lubrication System has 1 outlet (LUB-B-1) or 2 outlets (LUB-B-2).
- The battery must be changed whenever the disposable lubricant cartridge is changed.

1.1 Warning

The Lubricus Lubrication System is designed for use in normal industrial environments, but not for use in or on motor vehicles.

Use **only original Lubricus spare parts and accessories** (cartridges, fittings, connectors, tubes and battery packs). Any other batteries may damage the electronics and cause malfunction.

1.2 Scope of supply

The scope of supply may vary from country to country. Standard supply includes:

- the Lubricus Lubrication System (1 or 2 outlets);
- tube connector attached to the outlet(s) for medium-pressure PA tube 6 x 4 (Ø 6mm outer and Ø 4mm inner diameter)
- Operating Instructions

1.3 Overview – the Lubricus Lubrication System

Installing the Lubricus Lubrication System is simple. These instructions should help you to install your pump swiftly and easily, and to quickly learn the basics.

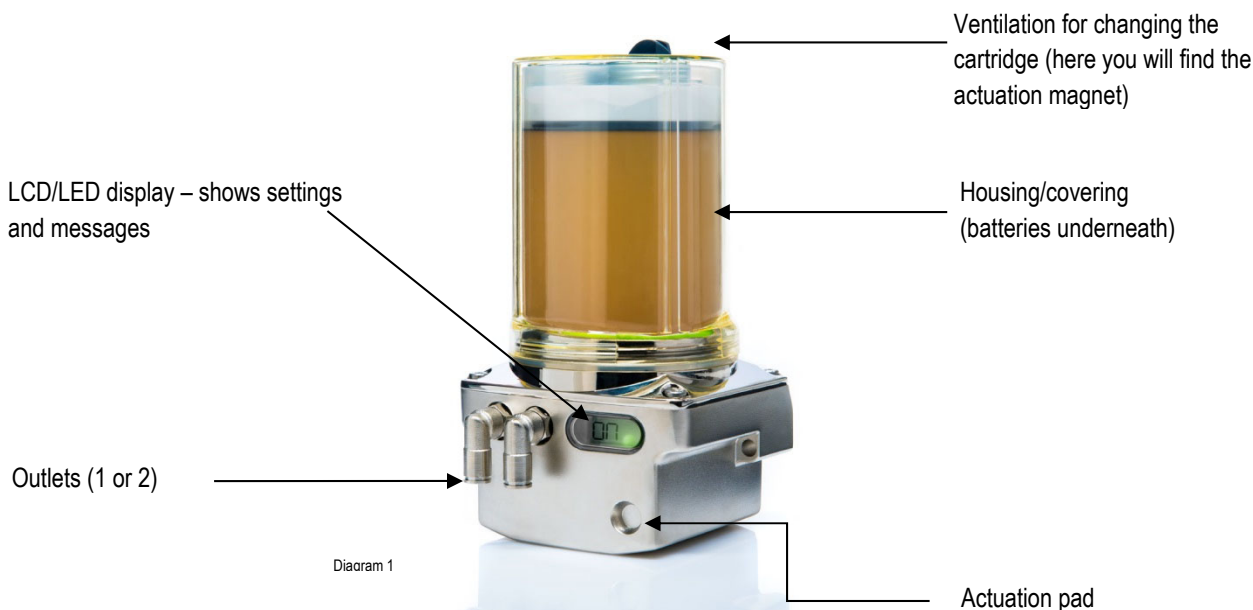

Please note!

Unused outlets should not be closed!

1.4 Symbols & Notes

Please pay attention, not only to these safety instructions, but also to the special safety instructions on other pages.



This symbol warns of electrical voltage.



This general danger symbol denotes safety instructions, the disregarding of which could lead to bodily harm.

Attention!

This heading is used if incorrect compliance or non-compliance with the Operating Instructions or specified work procedures etc. may result in damage of the system.

Please note!

This term will be used to draw your attention to special information.

Instructions attached directly to the machine must be strictly followed and kept in clearly legible condition!

1.5 Intended Use

Attention!

The Lubricus Lubrication System is **only** approved for **industrial use**. The Lubricus Lubrication System may only be used in accordance with the Technical Data (see chapter "Technical Data").

Unauthorised **structural changes** to the Lubricus Lubrication System are **not permitted**.

We do not assume liability for damages to persons or machines resulting from such.

Additional instructions for use in conformity with the intended use:

- pay attention to all information in the Operating Instructions;
- carry out all maintenance work;
- use only Gruetzner GmbH lubrication tubes and connectors;
- **follow** all appropriate regulations for **work safety** and **accident prevention** during the entire lifespan of the Lubricus Lubrication System;
- only qualified and authorized personnel should carry out work of any kind on the Lubricus Lubrication System.

Attention!

Other uses or uses beyond those described above shall be deemed as not in conformity with the intended use.

1.6 Liability and extent of guarantee

Proper functioning of the Lubricus Lubrication System can only be achieved through use of recommended lubricants from the **original Lubricus range of accessories**, and by observation of all installation, operation and maintenance instructions. Gruetzner GmbH excludes all liability if these instructions are not observed.

Gruetzner GmbH grants guarantees concerning operating safety, reliability and performance only under the following conditions:

- assembly, installation, maintenance and repairs are carried out by qualified staff only;
- hazardous hot or cold machine parts must be shielded to prevent skin contact;
- the Lubricus Lubrication System must be used according to the Technical Data and instructions;
- the limit values stated in the Technical Data are under no circumstances to be exceeded;
- retrofitting and repair work on the Lubricus Lubrication System may only be carried out by the manufacturer;
- the lubrication system must be protected against damp and wet.

If a lubricant that has not yet been tested for compatibility with the Lubricus Lubrication System be supplied or requested for use in the Lubricus Lubrication System by the purchaser/customer, the purchaser/customer undertakes the risk and responsibility.

This product is subject to strict production controls and fulfils our company's factory specifications. However, guarantee of testing of each individual case cannot be given due to the numerous factors involved.

We therefore strongly recommend that test runs be carried out.

All liability is excluded.

The Lubricus Lubrication System lubricant cartridge has been constructed and produced for **one-time use** only. Multiple use of the lubricant cartridge is not envisaged. After being used once, the lubricant cartridge is to be completely replaced; refilling is not permitted. Noncompliance will lead to nullification of the guarantee.

For guarantee conditions see the sales and delivery conditions of Gruetzner GmbH

2) Safety Information

Basic information, which must be followed during assembly, operation and maintenance, is listed as follows. These Operating Instructions must be read by all installation and operation staff before assembly and operation, and must be permanently available on site.

All personnel involved in installation, maintenance and operation of the system are to read these instructions carefully before beginning assembly and operation.

2.1 General safety information

2.1.1 Qualification and training of personnel



All operation, maintenance, service and installation personnel must be appropriately qualified for this work. Responsibility and supervision of the personnel must be clearly defined by the end user. If staff do not have the necessary knowledge, they must be trained and instructed. The end user must ensure that staff have completely understood the contents of the Operating Instructions.

2.1.2 Danger of non-compliance with the safety instructions



Non-compliance with the **safety information** can be **dangerous for people**, environment and machines. Non-compliance with the safety information can mean the loss of any or all damage claims. In certain cases, non-compliance can, for example, lead to the following hazards:

- malfunction of important system functions.
- malfunction of prescribed methods of maintenance and servicing.
- danger to people due to electrical, mechanical and chemical effects.
- danger to the environment due to leakage of dangerous substances.

2.1.3 Safety information for end user / operating staff



- Moving, rotating, hot or cold machine parts are to be securely shielded on site to prevent accidental contact. The shielding on moving or rotating parts is not to be removed.
- Leakages of dangerous materials are to be removed in such a way as not to endanger people or the environment.
- Legal regulations are to be complied with.
- Electrical hazards are to be eliminated.

2.1.4. Safety information for maintenance, inspection and assembly work



All **maintenance, inspection and installation work** may only be carried out **by trained specialists** who have been informed appropriately by carefully studying the Operating Instructions.

All work must only be carried out when the **machine is switched off** and while wearing appropriate **protective clothing**. Always comply with the procedures for shut down as described in the Operating Instructions.

All safety and protective equipment must be replaced immediately after completing work.

Environmentally hazardous substances must be disposed of in accordance with local regulations.

Secure the system during maintenance and repair work against intentional or unintentional operation.

Dispose of lubricants in accordance with the safety data sheets of the lubricant manufacturer.

2.1.5 Unauthorised modification and manufacture of spare parts



Modification and alteration of the system is not permitted. **Original spare parts** and accessories authorised by the manufacturer are for **safety** purposes. Using other parts can result in loss of liability for claims resulting out of this. Gruetzner GmbH does not guarantee and is not liable for components retrofitted by the end user.

2.1.6 Prohibited methods of operation

Operational security of the Lubricus Lubrication System is only guaranteed if it **is operated in accordance with the Operating Instructions**. The limit values listed in the Technical Data are under no circumstances to be exceeded.

2.1.7 General hazard warning



All components of the system are designed in accordance with the prevailing regulations of the construction of technical machines regarding operational safety and accident prevention. Nevertheless, operation can lead to dangers for the user, third parties or other technical facilities. Therefore, the Lubricus Lubrication System may only be used for its intended purpose in **technically fault-free condition**. This may only be carried out under compliance with the safety regulations and the Operating Instructions.

Therefore, please **regularly check** the Lubricus Lubrication System and its attachments for possible **damage** or **leaks**.

2.2 Transport and storage

Use suitable lifting gear for transport. Do not throw the Lubricus Lubrication System or expose it to heavy buffeting. Store the Lubricus Lubrication System in a cool and dry place to avoid corrosion of the system's individual parts.



Comply with valid safety and accident prevention instructions when transporting.
Wear suitable protection clothing if necessary!

2.3 Installation



The following conditions have to be satisfied during the installation of this Lubricus Lubrication System so that it can be assembled to a complete machine without affecting the health and safety of humans.

To prevent the formation of condensation, the housing of the Lubricus Lubrication System should not be exposed to direct sunlight or radiant heat.

The Lubricus Lubrication System must be protected against damp and wet. We strongly recommend that the lubrication system be enclosed in a housing.

Lubricus Lubrication Systems should never be exposed to outside weather conditions. If using outdoors, ensure the system has suitable protection (e.g. housing) and never use this product in or under water.

2.3.1 Electrical connection



- Only a qualified electrician should connect the power supply!
- Connection of electrical components is to be carried out professionally.
- Compare the voltage details with the existing power supply voltage!

2.4 Maintenance



- Disconnect the system from the mains before starting with **maintenance or repair work**.
- **Maintenance and repair** work may only be done with the system **completely switched off**.
- Check the surface temperature of the Lubricus Lubrication System to **avoid burns**.
- Always wear heat-resistance gloves!
- Ensure the system cannot be restarted during maintenance and repair work!

3) Function/Principle

After starting, the integrated pump transports the lubricant to the outlets according to the settings that have been made. The integrated electronics control and monitor the amount of lubricant and the time intervals between lubrications.

The total operating period of the lubricant cartridge and the desired lubrication intervals have to be programmed before starting the Lubricus Lubrication System.

3.1 Starting

- Connecting/installing
- Switching on
- Using the basic settings or
- Setting the desired emptying time of the lubricant cartridge (P1)
- Setting the desired amount of lubricant per lubrication stroke (P2)

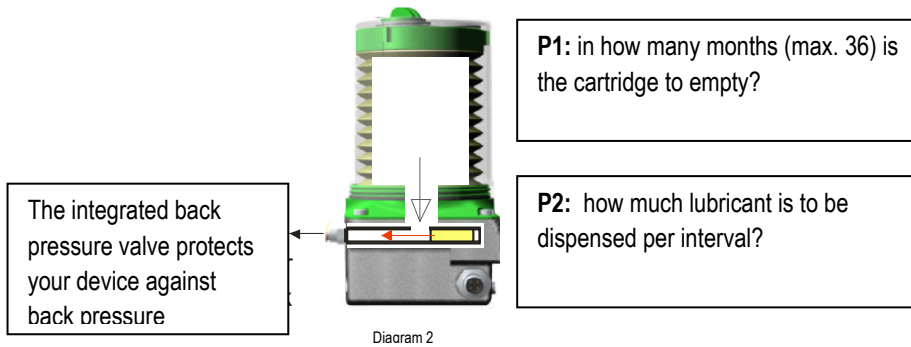

Diagram 2

3.2 Setting options

The basic settings P₁: 12 months (emptying time for the cartridge, 400cm³) and P₂: 01 cycle (desired amount of lubricant per interval) can easily be customised.

Table for LUB-B-1: Operating time and amount of lubricant at different settings (how often and how much is to be dispensed?).

LUB-B-1 (=1 outlet)	P1 setting (operating period) = emptying time of lubricant cartridge (400cm ³) in months						
	Operating time (months)	1	3	6	12	18	24
Result: lubricant amount per month (cm ³)	400	133	67	33	22	17	11

Table 1

P1: here, the first step is to set the emptying time period of the cartridge. Time period: 1–36 months

LUB-B-1 (=1 outlet)	P2 setting (number of strokes) = amount of lubricant per lubrication interval				
	Number of strokes	1	5	10	20
Amount of lubricant per interval	0.15cm ³	0.75cm ³	1.5cm ³	3.0cm ³	4.5cm ³
Result: number of lubrication intervals per operating period	2,700	540	270	135	90

Table 2

P2: here, you set the number of strokes per lubrication interval (0.15cm³ per stroke). Select: 1–30 strokes

Table for LUB-B-2: Operating time and amount of lubricant per outlet at different settings

LUB-B-2 (=2 outlets)	P1 setting (operating period) = emptying time of lubricant cartridge (400cm ³) in months						
Operating time (months)	1	3	6	12	18	24	36
Result: amount of lubricant per outlet per month (cm ³)	200	67	33	17	11	8	5,5

Table 3

LUB-B-2 (=2 outlets)	P2 setting (number of strokes) = amount of lubricant per lubrication interval				
Number of strokes	1	5	10	20	30
Amount of lubricant per interval and outlet	0.15cm ³	0.75cm ³	1.5cm ³	3.0cm ³	4.5cm ³
Result: number of lubrication intervals per outlet per operating period	1,350	270	135	68	45

Table 4

You will find a detailed overview of the various setting options in the appendix of these Operating Instructions.

Using the table

- 1. Establishing operating period:**
with how much lubricant is the lubrication point to be lubricated per month?
The result is the emptying time (**P₁**) of the lubricant cartridge in months.
The cartridge empties itself in the **P₁** determined time period irrespective of the strokes selected (**P₂**).
- 2. Establishing the amount of lubrication per stroke:**
how much lubricant should be regularly dispensed to the lubrication point?
The result is the number of lubrication intervals (**P₂**) per operating period.

Please note: the total amount of lubricant during the operating period is independent of the selected lubrication interval!

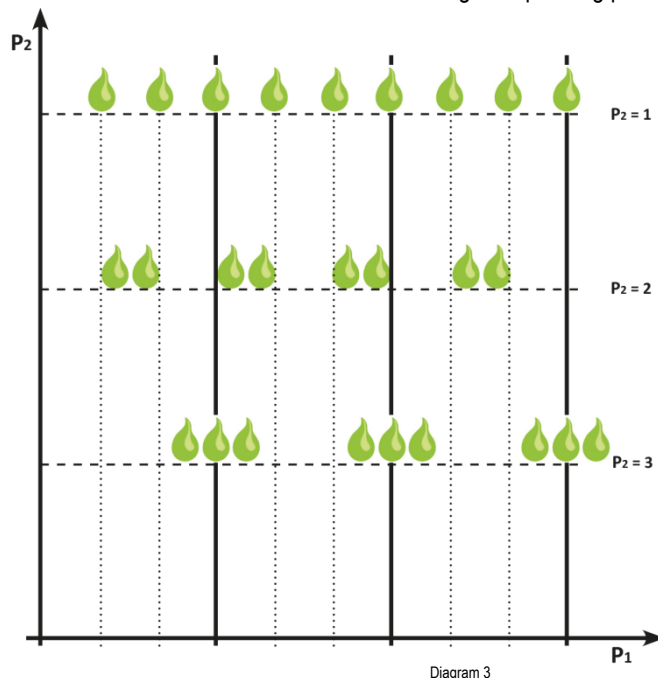

P₂ Small: small amounts of lubricant, but dispensed more frequently.

P₂ Large: large amounts of lubricant, but dispensed less frequently.

The total amount per lubrication point is determined by the emptying time P₁ only.

Example LUB-B-2:

During the entire emptying time of the lubricant cartridge (= operating period), the lubrication points are lubricated: at P₂=1 a total of 1,350 times per outlet with 0.15cm³; at P₂=10 a total of 135 times per outlet with 1.5cm³; at P₂=20 a total of 67 times per outlet with 3.0cm³; at P₂=30 a total of 45 times per outlet with 4.5cm³ – always at the same time interval. Intermediate steps are possible.

You will find a detailed overview of the various setting options in the appendix of these Operating Instructions.
Commissioning (switch on / switch off / resetting)

4.1 General information

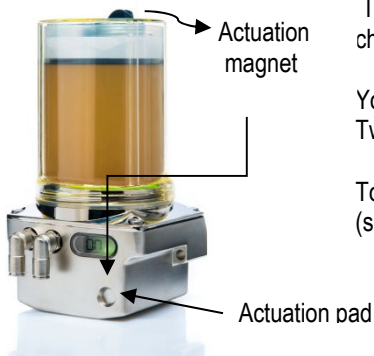

The actuation magnet is required to switch the Lubricus Lubrication System on and off, or change the programming.

You will find the magnet on top of the Lubricus housing/plastic cover
Twist to remove the magnet (Close => Open).

To switch Lubricus on or off, hold the tip of the actuation magnet against the actuation pad (small recess) on the front of the housing.

4.2 Starting Lubricus for the first time



	LED	Display	Action to be carried out	Description
1		OFF	Release latch (= ventilation) and remove actuation magnet. Twist Close => Open	
2	 3 x	OFF	Hold the actuation magnet against the actuation pad	To switch on , hold the actuation magnet against the actuation pad (press and hold) until the red LED on the display has blinked 3 times => then remove actuation magnet.
3		ON	-	Display changes from "OFF" to "ON": Now the basic settings are displayed.
3a		03	-	Display 03 : 3.0V battery operation
3b		A01	-	Display A01 or A02 : 1 or 2 outlets – depending on model
3c		P12	-	Display P₁ : lubricant cartridge emptying time (standard setting: 12 months)
3d		P01	-	Display P₂ : number of strokes (= number of pump strokes á 0.15cm ³ per lubrication interval, standard setting: 1)
4			-	"On" flashes on the display for approx. 3 seconds. If no action is taken, Lubricus goes into operation mode and functions according to the settings P1 and P2 => screw actuation magnet into the ventilation recess and twist OPEN => CLOSE.

Table 5

4.3 Switching off Lubricus

	LED	Display	Action to be carried out	Description
1	 3 x	ON ⇒ OFF	Hold the actuation magnet against the actuation pad	If you wish to switch the device off again, hold the actuation magnet against the actuation pad again until the red LED blinks 3 times => Lubricus switches itself off, the display shows "OFF"

Table 6

4.4 Ventilating the lubrication system

Depending upon scope of supply and ordered specifications (e.g. special filling), the lubricant cartridge is already installed or has been separately packed.

If the lubricant cartridge has not already been installed, the Lubricus pump body/bodies **must** be ventilated before commissioning (i.e. the pump body/bodies must be filled with grease) in order to guarantee proper operation. It takes approx. 20–25 dispensing strokes to fill a pump body.

Ventilation of the pump body is independent of the desired P₁ and P₂ settings.

Attention!

If the lubricant cartridge is already installed upon delivery, then ventilation has already been carried out by the manufacturer!

How to ventilate the Lubricus Lubrication System:

	LED	Info	Action to be carried out	Description
1			Open the covering of the Lubricus Lubrication System	Unscrew the housing
2			Place the Lubricus battery in its compartment and connect the polarised plug connection	Connect to power
3			Insert the lubricant cartridge and push down lightly, twist to the right to secure	Insert lubricant cartridge and close housing
4		OFF → ON	Switch the Lubricus on by letting the red LED blink 3 times	Switch on: see page 10
5		ON	As soon as the device is in operating mode (display shows ON), allow the red LED to blink seven times in order to start the filling function	Activating filling function
6		run	Continue this process until lubricant comes out of the outlets	Approx. 20-25 dispensing strokes are necessary. While running the display shows "RUN"
7			Connect the Lubricus Lubrication System to the supply lines that have been pre-filled with the same lubricant	The lubrication tubes should not be longer than 5m and should have a minimum diameter of 4mm. Use only original Lubricus lubrication tubes.
8			Now set up the Lubricus Lubrication System as desired (see page 12).	

Table 7

4.5 Programming Lubricus

P_1 (operating period in months) and P_2 (number of pump strokes) are programmable.

P_1 : operating period from 1 to 36 months possible.

Lubricus dispenses lubricant evenly according to the number of months and the number of strokes (P_2).

P_2 : stroke number between 1 and 30 possible (0.15cm³ – 4.5cm³ per interval)



	LED	Display	Action to be carried out	Description
1		OFF	Release latch (= ventilation) and remove actuation magnet. Twist Close => Open	
2	 3 x	OFF	Hold the actuation magnet against the actuation pad	To switch on , hold the actuation magnet against the actuation pad (press and hold) until the red LED on the display has blinked 3 times => then remove actuation magnet.
3		ON	-	Display changes from "OFF" to "ON": Now the basic settings are displayed.
3a		03	-	Display 03 : 3.0V battery operation
3b		A01	-	Display A01 or A02 : 1 or 2 outlets – depending on model
3c		P12	-	Display P_1 : lubricant cartridge emptying time (standard setting: 12 months)
3d		P01	-	Display P_2 : number of strokes (= number of pump strokes á 0.15cm ³ per lubrication interval, standard setting: 1)
4			While "ON" is blinking , hold the actuation magnet on the actuation pad (approx. 2 seconds) until the display shows P_1 . ($P_1=12$)	Now in setting mode
5		P01 ⇒ P36	The value can be changed by " tapping " the actuation pad with the magnet. Holding the magnet on the pad will make the display "run"; short tapping increases the value by 1.	If there is a pause of 2 seconds, the current value is saved and the display changes to P_2 .
6		P01 ⇒ P30	The value can be changed by " tapping " the actuation pad with the magnet. Holding the magnet on the pad will make the display "run"; short tapping increases the value by 1.	If no more changes are made through touching the actuation pad, the changes to the basic settings are completed and the values are saved in the memory.
9	 every 60s	ON	Insert the actuation magnet in the ventilation recess, twist OPEN => CLOSE	Display changes to ON. Lubricus immediately operates according to the saved settings. The green LED blinks every 60 seconds.
10			If the time interval was accidentally missed in order to enter setting mode (ON blinking): switch off the device (allow LED to blink 3 times) and restart (allow to blink red again 3 times) and repeat as described at 4).	

Table 8

4.6 Quick Check – dispensing an individual dose

For test and sample purposes the installed lubrication pump can easily be used to dispense small amounts of lubricant. For this purpose, the available pressure between the lubrication point and pump is measured. The value displayed is the back pressure in bar.

To carry out a Quick Check, hold the actuation magnet on the actuation pad until the red LED blinks twice.
An individual dose is dispensed and Lubricus transports 0.15 cm³ per outlet.



	LED	Info	Action to be carried out	Description
1	 3 x	OFF ⇒ ON	Switch the Lubricus on by letting the red LED blink 3 times	Switch on: see page 10
2	 2 x	ON	As soon as the device is in operating mode (display shows ON), allow the red LED to blink twice in order to dispense an individual dose	Dispensing an individual dose "Quick Check"
3		run	-	While running, the display shows "RUN". Lubricus dispenses 0.15 cm ³ per outlet once.
4		024	-	After pumping, the measured back pressure is shown on the display (in bar). For example: 024 equates to 24 bar. Accuracy: ± 15 %.

Table 9

Attention!

Individual doses shorten the total life-span of the lubrication system. If you have dispensed several individual doses, the shortened total operation time has to be taken into consideration with regards to maintenance.

4.7 Switching off Lubricus

To switch off, hold the actuation magnet against the actuation pad.

Duration: until the red LED blinks 3 times on the display.

The display changes to "OFF"; all settings remain stored in the memory.

Holding the actuation magnet to the actuation pad for longer will not switch the device off.

	LED	Display	Action to be carried out	Description
1	 3 x	ON ⇒ OFF	Hold the actuation magnet against the actuation pad	If you wish to switch the device off again, hold the actuation magnet against the actuation pad again until the red LED blinks 3 times => Lubricus switches itself off, the display shows "OFF"

Table 10

5) Display, Messages, Errors (shown on LCD/LED)

Malfunctions will be recognised by the Lubricus electronics and shown on the display. The device will switch itself off and no further lubricant will be dispensed.



As long as the green LED is blinking every 60 seconds during operation, everything is working properly.



If the red LED blinks every 5 seconds: malfunction (empty, battery needs changing, excess pressure). An error message will be displayed.

5.1 Error messages on the display:



	LED	Display	Malfunction	Cause	Remedy
1	 every 5 seconds	E1	Level indicator	Lubricant cartridge is empty or missing. Pumping stops!	Replace lubricant cartridge and change battery
2	 every 5 seconds	E2	Back pressure too high	Back pressure was too high three times in a row. The lubrication point may be blocked, or the tubing is too long, or the grease is too stiff/hard. Pumping stops!	Fix the excess back pressure (>70 bar), switch the pump "OFF" and switch back "ON". The error counter will reset. Lubricus restarts.
3	 every 5 seconds	E3	Battery level is too low	Battery empty. Lubricus stops	Change battery

Table 11

System malfunctions: switch the device off and on again, the error counter will reset. Settings in the memory will not be deleted.

6) Maintenance: cartridge and battery changing

Apart from changing the cartridge and battery, no maintenance is necessary.

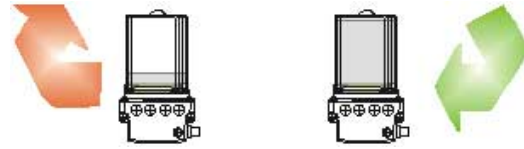







	Action	Description		Action	Description
1		Switch off the pump: display – shows "OFF"			
2		Remove housing by twisting to the left	6		Remove protective covering from the new cartridge. Use oil felt pad if inserting oil cartridges!
3		Remove empty lubrication cartridge	7		Insert the new cartridge with twisting movement
4		Carefully remove battery pack and disconnect plug	8		Replace housing, pushing down lightly, twist to the right to secure
5		Connect new battery pack – establish contact (snap in connections). Insert battery, cable and plug into the battery compartment!	9		Lubricus is ready to operate again! Switch on and off using the actuation magnet

Table 12

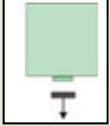
The pump drive and electronics must always be protected against damp and wet. Please always change the lubrication cartridge in a dry environment.

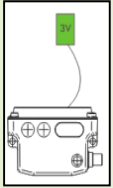
7) Technical Data

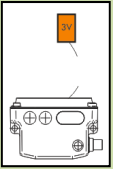

Diagram 5

	Lubricus B-1 / Lubricus B-2
Lubrication volume	400 cm ³ in a rigid, disposable cartridge.
Lubricant type	Oil or grease up to NLGI 2
Functional principle	Piston pump
Dose volume per stroke	0.15cm ³
Dose amount per lubrication cycle	0.15 to 4.5cm ³
Number of strokes per cartridge	LUB-B-1: 2,700 LUB-B-2: 1,350 per outlet
Number of outlets	1 (LUB-B-1); 2 (LUB-B-2)
Connection	Tube with 6mm outer-diameter, maximum pressure up to 150 bar
Operating period per cartridge	1–36 months
Operating pressure	Max. 70 bar
Operating temperature range	-20°C up to +70°C
Dimensions, max., W x H x D	112 x 196 x 94mm
Weight without lubricant	1,120g
Integrated controller	Microelectronic
Pressure monitoring	Integrated, electronic
Level monitoring	Integrated , dry reed contact
Capacity monitoring	Integrated, LCD
Connector	M12x1, 4-pole
Operating voltage	3V DC (battery)
Progressive distributor control	Suitable
Individual dose	For system controlling, testing and additional lubrication amount 0.15cm ³ per dose

Table 13

8) Installation – Lubricus Lubrication System

2 screws (not supplied) Ø 6mm (for example, M6x40 or longer) are required to mount your Lubricus. Tightening torque for the screws = 5Nm. 3 points on the rear side assure a secure hold.

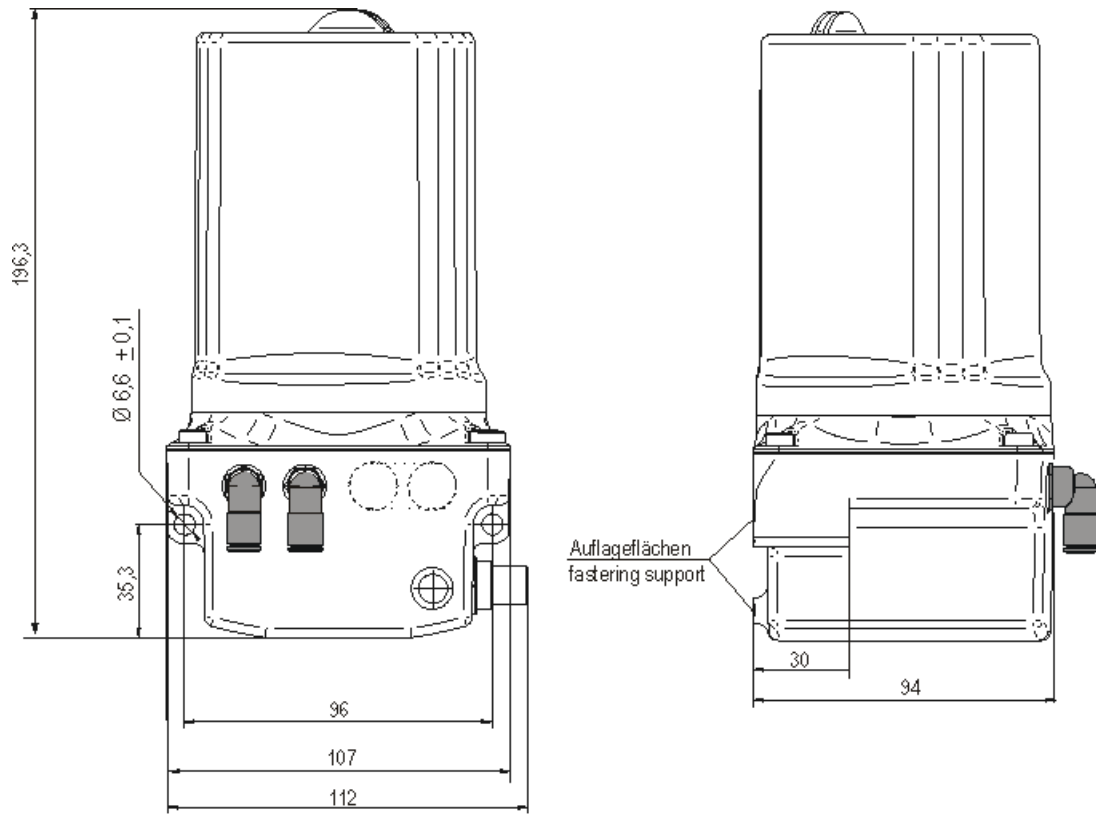

Diagram 6

9) Recommended tube lengths

Use only Gruetzner GmbH lubrication tubes and connectors.

The lubrication tubes must have an inner diameter of **at least 4mm**

The Lubricus Lubrication System operates at a maximum supply pressure of 70 bar.

At temperatures of 20°C/68°, the **lubrication tubes are not to exceed 5m**.

The lubrication tubes are to be shortened accordingly for lower temperatures.

The values listed above only apply in the case of a **direct connection** between the Lubricus Lubrication System and the lubrication point. If progressive distributors are being used, maximum lubrication tube lengths are to be halved subject to the temperature.

Installation of a progressive distributor must be carried out **immediately** downstream from the tube connector/outlet of the Lubricus Lubrication System. Use only original Gruetzner GmbH progressive distributors.

All values listed above apply to the **standard lubricants** supplied by Gruetzner GmbH.

Please note!

The following applies for low temperatures, stiff/hard grease, NLGI class 2 and complex uses with high back pressure:

- **keep tube lengths as short as possible**
- **minimum inner diameter is Ø 4mm**

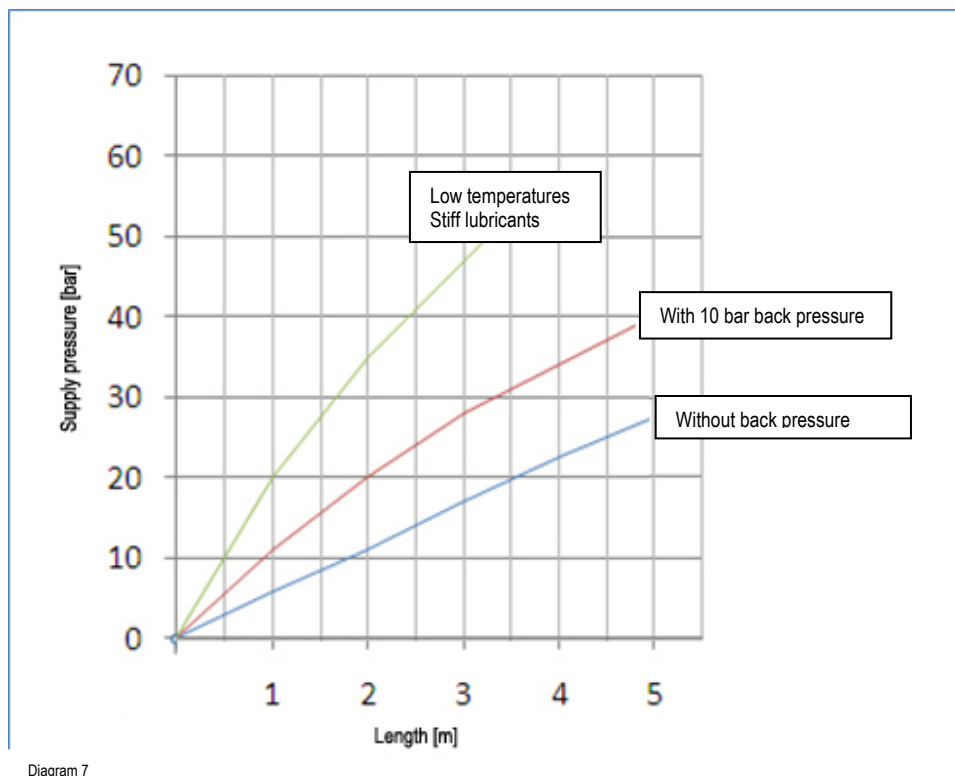

Diagram 7

Diagram 7: Required supply pressure dependent upon the tube length (tested with 6x4mm tubing)

10) Disposal

Please note!

When changing lubricants, the waste disposal instructions of the lubricant manufacturer must be observed!
Regional applicable laws and regulations are to be observed when disposing of the Lubricus Lubrication System.
See your applicable national/regional disposal guidelines for more information.

Batteries (lithium) should not be disposed of in the domestic waste.

Emptied cartridges contain lubrication residue!
Please dispose of together with other oleaginous waste!

Gruetzner GmbH

Kohlenhofstr. 60

90443 Nuremberg, Germany

info@G-LUBE.com

www.lubricus.de

Tel.: +49 (0)911 - 277 399 0

Fax: +49 (0)911 - 277 399 99

11) Appendix

11.1 List of tables and diagrams

Diagrams

Diagram 1:	Lubricus Lubrication System overview	3
Diagram 2:	Lubricus Lubrication System / settings	8
Diagram 3:	Number of lubrication strokes	9
Diagram 4:	Lubricus Lubrication System actuation magnet / actuation	10
Diagram 5:	Lubricus Lubrication System LUB-B-1 and LUB-B-2	16
Diagram 6:	Lubricus Lubrication System / installation	17
Diagram 7:	Relationship between tube length and back pressure	18

Tables

Table 1:	Setting operating period, Lubricus Lubrication System LUB-B-1	8
Table 2:	Setting number of strokes, Lubricus Lubrication System LUB-B-1	8
Table 3:	Setting operating period, Lubricus Lubrication System LUB-B-2	9
Table 4:	Setting number of strokes, Lubricus Lubrication System LUB-B-2	9
Table 5:	Starting Lubricus for the first time	10
Table 6:	Switching off Lubricus	10
Table 7:	Ventilating the Lubricus Lubrication System	11
Table 7:	Programming Lubricus	12
Table 9:	Quick Check – dispensing an individual dose	13
Table 10:	Switching off Lubricus	13
Table 11:	Error messages on the display	14
Table 12):	Maintenance: cartridge and battery changing	15
Table 13:	Technical Data	16